

Doppia Mappa *Multilever lock*



ASSA ABLOY, the global leader
in door opening solutions



Doppia Mappa (Meccanica) Multilever Lock (Mechanical)

Serratura meccanica da fascia a doppia mappa
ad 1 o 3 punti di chiusura

Caratteristiche tecniche:

- Versioni
 - Scrocco e catenaccio
 - Solo catenaccio
 - Rullo e catenaccio
 - Catenaccio a **4 mandate**
 - Reversibile
 - 1 o 3 punti di chiusura
 - Asole per **il montaggio facilitato delle aste interne/esterne**
 - Coprifrontale in acciaio inox
 - Entrate 70 e 90 mm
-
- **Confezione:**
 - 3 Chiavi
 - 2 Borchie in nylon con occlusore
 - 2 viti/boccole fissaggio aste (3 punti)
 - Viti fissaggio borchie
 - Viti inox fissaggio serratura

Da ordinare a parte:

- Contropiastre

*Mechanical multilever midrail lock
1 or 3 locking points*

Features:



- Versions
 - Latch and dead bolt
 - Dead bolt only
 - Roller latch and dead bolt
 - **4 throws** dead bolt
 - Reversible
 - 1 or 3 locking points
 - Slots for **easy rod fixing**
 - **Stainless steel** forend cover
 - Backsets 70 e 90 mm
-
- **Packaging:**
 - 3 Keys
 - 2 Nylon covers
 - 2 Fixing screws rods (3 points)
 - Fixing screws covers
 - Fixing inox screws lock

To be ordered separately:

- Strikes

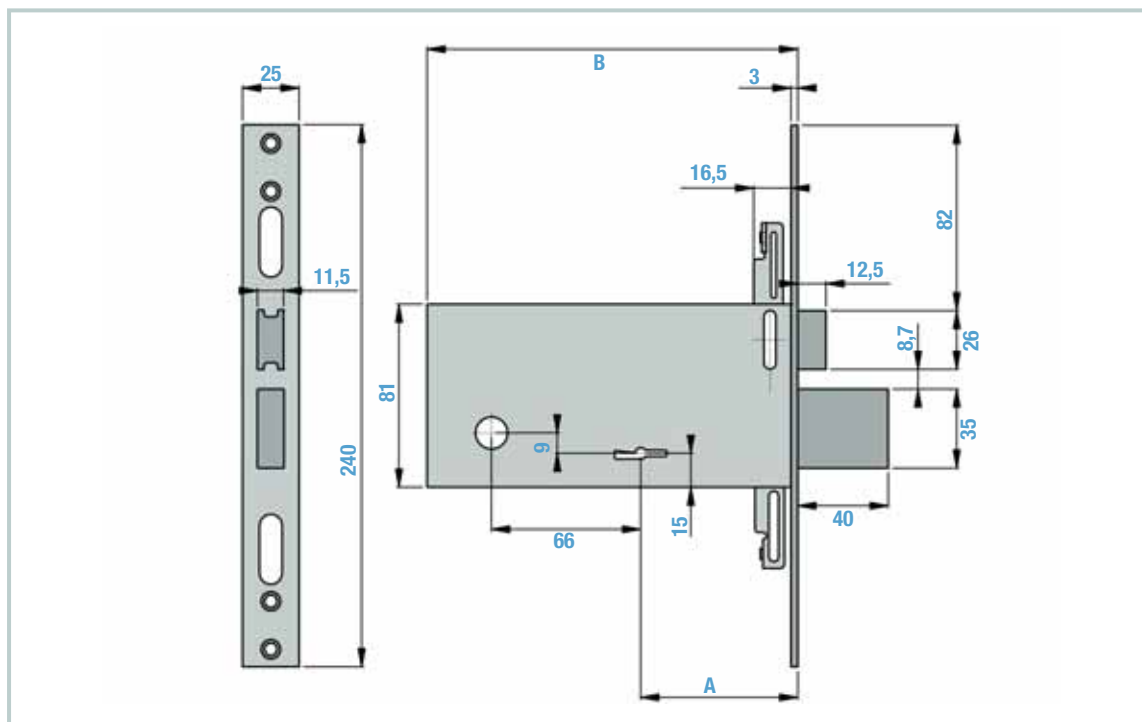



Codice / Code	A Entrata/Backset	B mm	N° chiusure Nr looking point		
---------------	----------------------	---------	---------------------------------	---	---

Versione unificata per aste interne ed esterne
Standardized version for both internal and external rods

Scrocco e catenaccio
Latch and dead bolt

6871	70	165	1	1.186	10
6891	90	185	1	1.276	10
6873	70	165	3	1.354	10
6893	90	185	3	1.418	10

Non intercambiabili con le serie 6871/3 e 6891/3
Not suitable to 6871/3 and 6891/3

6801/SA	70	165	1	1.220	10
6803/SA	70	165	3	1.292	10

Versione unificata per aste interne ed esterne
Standardized version for both internal and external rods

Rullo e catenaccio
Roller latch
and dead bolt

6871R	70	165	1	1.138	10
6891R	90	185	1	1.224	10
6873R	70	165	3	1.304	10
6893R	90	185	3	1.370	10

Non intercambiabili con le serie 6871/3 e 6891/3
Not suitable to 6871/3 and 6891/3

6801R/SA	70	165	1	1.160	10
6803R/SA	70	165	3	1.238	10

Versione unificata per aste interne ed esterne
Standardized version for both internal and external rods

Solo catenaccio
Dead bolt only

6871C	70	165	1	1.056	10
6891C	90	185	1	1.124	10
6873C	70	165	3	1.210	10
6893C	90	185	3	1.272	10

Non intercambiabili con le serie 6871/3 e 6891/3
Not suitable to 6871/3 and 6891/3

6801C/SA	70	165	1	1.074	10
6803C/SA	70	165	3	1.136	10

Doppia Mappa (Elettrica) *Multilever Lock (Electric)*

**Elettroserratura da fascia a doppia mappa
ad 1 o 3 punti di chiusura**

Caratteristiche tecniche:

- Scrocco e catenaccio
- Catenaccio a **4 mandate**
- Reversibile
- 1 o 3 punti di chiusura
- Asole per il **montaggio facilitato delle aste** interne/esterne
- Coprifrontale in **acciaio inox**
- Entrate 70 e 90 mm.
- Alimentazione 12 V

Confezione:

- 3 Chiavi
- 2 Borchie in nylon con occlusore
- 2 viti/boccole fissaggio aste (3 punti)
- Viti fissaggio borchie
- Viti inox fissaggio serratura

Da ordinare a parte:

- Contropiastre

**Electric multilever midrail lock
1 or 3 locking points**

Features:

- Latch and dead bolt
- **4 Throws** dead bolt
- Reversible
- 1 or 3 locking points
- Slots for **easy rod fixing**
- **Stainless steel** forend cover
- Backsets 70 and 90 mm.
- Power supply 12 V

Packaging:



- 3 Keys
- 2 Nylon covers
- 2 Fixing screws rods (3 points)
- Fixing screws covers
- Fixing inox screws lock

To be ordered separately:

- Strikes

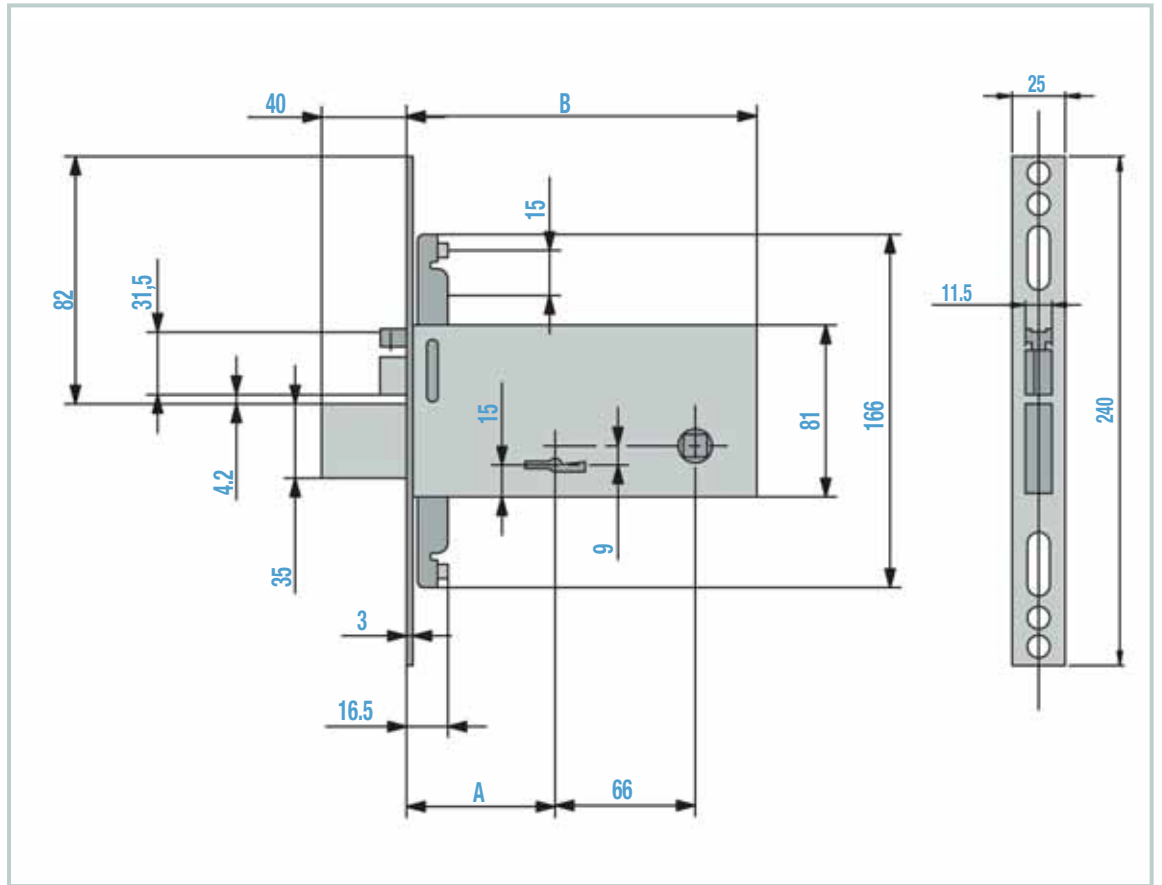



Codice / Code	A Entrata/Backset	B mm	N° chiusure Nr looking point		
---------------	----------------------	---------	---------------------------------	---	---

Versione unificata per aste interne ed esterne
 Standardized version for both internal and external rods

Scrocco e catenaccio
 Latch and dead bolt

6971	70	165	1	1.202	10
6991	90	185	1	1.280	10
6973	70	165	3	1.360	10
6993	90	185	3	1.438	10



Non intercambiabili con le serie 6971/3 e 6991/3
 Not suitable to 6971/3 and 6991/3

6901/SA	70	165	1	1.246	10
6903/SA	70	165	3	1.320	10



Accessori per Doppia Mappa

Accessories for Multilever midrail lock





Codice / Code		
Bocchetta a pavimento - <i>Floor striker</i>		
6816	30	1
Bocchetta a pavimento con molla antipolvere - <i>Floor striker with dust cup</i>		
6816/1	30	1



Codice / Code		
Coppia attacchi per aste esterne spessore 5 mm <i>Set for central joint flush system 5 mm thickness</i>		
6850/4	74	1



Codice / Code		
Coppia borchie guida chiave <i>Escutcheon</i>		
6821	24	1



Codice / Code	Finitura/ Finish		
Doppia maniglia in lega presso fusa - <i>Double hand</i>			
7510	Nera/Black RAL 9011	706	15
7510/GR	Grigia/Grey RAL 7040	706	15
7510/WH	Bianca/White RAL 9010	706	15





Codice / Code		
Coppia contatti / <i>Contact set</i>		
6360	30	15



Codice / Code		
Bobine / <i>Coils</i>		
805	34	1

Chiavi grezze / *Key blanks*





Codice / Code		
Chiave Standard / <i>Standard Key - 78 mm.</i>		
520	22	10
Chiave Lunga / <i>Long Key - 91 mm.</i>		
520/L	26	10

Accessori per Doppia Mappa

Accessories for Multilever midrail lock



Codice / Code		
6807	1.300	1

Kit deviatori con catenaccio avanzante, con aste interne
Set of rod pulleys for internal rod sections



Codice / Code		
6817	370	10



Coppia aste piegate tradizionali per serie 6801 - 6803
Vertical rods for 6801 - 6803 series



Codice / Code		
6822	370	10

Coppia aste diritte tradizionali per serie 6801 - 6803
Vertical rods for 6801 - 6803 series



Codice / Code		
6827	370	10



Coppia aste piegate unificate per serie 6871/3 - 6891/3
Vertical rods for 6871/3 - 6891/3 series



Codice / Code		
6828	370	10

Coppia aste diritte unificate per serie 6871/3 - 6891/3
Vertical rods for 6871/3 - 6891/3 series



Codice / Code	mm		
6814	Ø 8	62	1
6815	Ø 6	55	1

Coppia puntali antisega da inserire nelle aste
Set of shoot ends saw resistant to insert in the rods



Codice / Code		
6843	35	100

Coppia attacchi M8 per aste filettate
Set M8 joint rods



ASSA ABLOY Italia S.p.A.
Via Modena 68 - 40017 San Giovanni in Persiceto (BO) Italy
Tel. +39 051 6812411 - Fax +39 051 827486
info@assaabloy.it - www.assaabloy.it

ASSA ABLOY is the global leader in door opening solutions, dedicated to satisfying end-user needs for security, safety and convenience.

www.assaabloy.com



ASSA ABLOY Italia S.p.A. si riserva di apportare in qualunque momento e senza preavviso le modifiche necessarie per migliorare ed evolvere le caratteristiche dei propri prodotti. Fotografie, illustrazioni e descrizioni sono da ritenersi indicative.
ASSA ABLOY Italia S.p.A. reserves the right at any time, and without notice, the necessary modifications in order to improve and evolve the characteristics of their products. Photographs, illustrations and descriptions ought to be considered as indicative.

H001505 / 01-2008